

# CLARKE<sup>®</sup>

## CONTRACTOR<sup>®</sup>



**1500W SDS DEMOLITION HAMMER**

**MODEL NO: CON1500DD**

PART NO: 6479509

### OPERATION & MAINTENANCE INSTRUCTIONS

UK  
CA | CE



ORIGINAL INSTRUCTIONS

GC10/23 - Rev 3

---

## INTRODUCTION

---

Thank you for purchasing this CLARKE Demolition Hammer. The CON1500DD is designed for breaking breeze blocks, brick, hard earth and concrete etc.

Before attempting to use this product, please read this manual thoroughly and follow the instructions carefully. In doing so you will ensure the safety of yourself and that of others around you, and you can look forward to your purchase giving you long and satisfactory service.

---

## GUARANTEE

---

This product is guaranteed against faulty manufacture for a period of 12 months from the date of purchase. Please keep your receipt which will be required as proof of purchase.

This guarantee is invalid if the product is found to have been abused or tampered with in any way, or not used for the purpose for which it was intended.

Faulty goods should be returned to their place of purchase, no product can be returned to us without prior permission.

This guarantee does not effect your statutory rights.

---

## ENVIRONMENTAL RECYCLING POLICY

---



Through purchase of this product, the customer is taking on the obligation to deal with the WEEE in accordance with the WEEE regulations in relation to the treatment, recycling & recovery and environmentally sound disposal of the WEEE.

In effect, this means that this product must not be disposed of with general household waste. It must be disposed of according to the laws governing Waste Electrical and Electronic Equipment (WEEE) at a recognised disposal facility.

---

# SAFETY PRECAUTIONS

---



**WARNING: READ ALL INSTRUCTIONS. FAILURE TO FOLLOW ALL INSTRUCTIONS LISTED BELOW MAY RESULT IN ELECTRIC SHOCK, FIRE AND/OR SERIOUS INJURY. THE TERM "POWER TOOL" IN ALL WARNINGS LISTED BELOW REFERS TO YOUR DEMOLITION HAMMER.**

---

## WORK AREA

1. Keep work area clean and well lit. Cluttered and dark areas invite accidents.
2. DO NOT operate power tools in explosive atmospheres, such as in the presence of flammable liquids or gases. Power tools can create sparks which may ignite the fumes.
3. Keep children and bystanders away while operating a power tool. Distractions can cause you to lose control.

## ELECTRICAL SAFETY

1. AVOID body contact with earthed or grounded surfaces such as pipes, radiators, ranges or refrigerators. There is an increased risk of electric shock if your body is earthed or grounded.
2. DO NOT expose power tools to rain or wet conditions. Water entering a power tool will increase the risk of electric shock.
3. When operating a power tool outdoors, use an extension cord suitable for outdoor use. Use of a cord suitable for outdoor use reduces the risk of electric shock.

## PERSONAL SAFETY

1. ONLY hold the tool using the handles when in use. DO NOT attempt to use the tool with one hand.
2. Stay alert, watch what you are doing and use common sense when operating a power tool. DO NOT use a power tool while you are tired or under the influence of drugs, alcohol or medication. A moment of inattention while operating power tools may result in personal injury.
3. ALWAYS use safety equipment. Safety equipment such as dust mask, non-skid safety shoes and hearing protection used for appropriate conditions will reduce personal injuries.
4. AVOID accidental starting. Ensure the switch is in the off position before connecting to the power supply.
5. DO NOT overreach. Keep proper footing and balance at all times. This enables better control of the power tool in unexpected situations.

6. Dress properly. DO NOT wear loose clothing or jewellery. Keep your hair, clothing and gloves away from moving parts. Loose clothes, jewellery or long hair can be caught in moving parts. ALWAYS use protective clothing for prevention of injury.
7. All hand held power tools vibrate to some extent, and this vibration is transmitted to the operator via the handles. Operators who are regularly exposed to vibration may suffer from Hand Arm Vibration Syndrome (HAVS), which includes 'dead hand', 'dead finger', and 'white finger'. These are painful conditions and are widespread in industries where vibrating tools are used. If you feel numbness or pain in hands or arms, STOP using the tool and take a rest. If symptoms persist seek medical advice.

### **POWER TOOL USE AND CARE**

1. DO NOT force the power tool. Use the correct power tool for your application. The correct power tool will do the job better and safer at the rate which it was designed.
2. DO NOT use the power tool if the switch does not turn it on and off. Any power tool that cannot be controlled with the switch is dangerous and must be repaired.
3. Disconnect the power before making any adjustments, changing accessories, or storing power tools. Such preventive safety measures reduce the risk of starting the power tool accidentally.
4. Store idle tools out of the reach of children and DO NOT allow persons unfamiliar with the power tool or these instructions to operate the power tool. Power tools are dangerous in the hands of untrained users.
5. Maintain power tools. Check for misalignment or binding of moving parts, breakage of parts and any other condition that may affect the power tools operation. If damaged, have the power tool repaired before use. Many accidents are caused by poorly maintained power tools.
6. Keep cutting tools sharp and clean. Poorly maintained cutting tools with sharp cutting edges are less likely to bind and are easier to control.
7. Use the power tool and accessories in accordance with these instructions and in the manner intended for the particular type of power tool, taking into account the working conditions and the work to be performed. Use of the power tool for operations different from intended could result in a hazardous situation.

### **SERVICING**

1. Have your power tool serviced by a qualified repair person using only identical replacement parts. This will ensure that the safety of the power tool is maintained.

## SPECIFICATIONS

<b>Model No.</b>	<b>CON1500DD</b>
Operating Voltage and Frequency	230V AC~ 50Hz -1 phase
Rated Input Power	1500W
Chuck capacity/type	SDS HEX 30mm
Impact Energy	45 Joules
Impact Rating	1900 (blows/min)
IP Rating	IP X0
Insulation Class	Class II
Sound Pressure Level	91.8 dB LpA
Guaranteed Sound Power Level	105 dB LWA
Vibration*	20.706 m/s <sup>2</sup>
Vibration Uncertainty Factor	1.5 m/s <sup>2</sup>
Weight	17.35 kg
Dimensions (LxHxW)	640 x 116 x 300 mm
Duty Cycle classification	S1 (Continuous)

\* = Please note that the application of the tool to a sole specialist task may produce a different average vibration emission. We recommend that a specific evaluation of the vibration emission is conducted prior to commencing with a specialist task.

## ELECTRICAL CONNECTIONS



**WARNING: READ THESE ELECTRICAL SAFETY INSTRUCTIONS THOROUGHLY BEFORE CONNECTING THE PRODUCT TO THE MAINS POWER SUPPLY.**

Before switching the product on, make sure that the voltage of your electricity supply is the same as that indicated on the rating plate. Connecting it to any other power source may cause damage.

If it is necessary to change the fuse in the plug, the fuse cover must be refitted. If the fuse cover becomes lost or damaged, the plug must not be used until a suitable replacement is obtained.

If the plug has to be changed due to damage, a replacement should be fitted, following the wiring instructions shown below. The old plug must be disposed of as insertion into a mains socket could cause an electrical hazard.



**WARNING: THE WIRES IN THE POWER CABLE OF THIS PRODUCT ARE COLOURED IN ACCORDANCE WITH THE FOLLOWING CODE:  
BLUE = NEUTRAL    BROWN = LIVE**

If the colours of the wires in the power cable of this product do not correspond with the markings on the terminals of your plug, proceed as follows.

- The **Blue** wire must be connected to the terminal which is marked **N** or coloured **Black**.
- The **Brown** wire must be connected to the terminal which is marked **L** or coloured **Red**.

**Plug must be BS1363/A approved.**

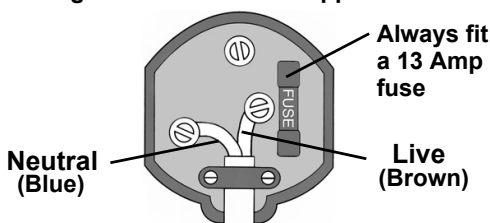

**Ensure that the outer sheath of the cable is firmly held by the clamp**

**We strongly recommend that this machine is connected to the mains supply via a Residual Current Device (RCD)**

If in any doubt, consult a qualified electrician. DO NOT attempt any repairs yourself.



**This symbol indicates that this is a Class II product and does not require an earth connection.**

# OVERVIEW/CONTENTS



NO	DESCRIPTION	NO	DESCRIPTION
1	SDS Hex Demolition hammer	5	34mm Flat Head Chisel
2	Moulded Carrying Case	6	Ring Spanner
3	Oil Bottle	7	5mm Hexagon Key
4	Bull Point Chisel	8	6mm Hexagon Key

---

## BEFORE USE

---

### OIL GAUGE/OIL TOP UP

This machine has an oil chamber which should be filled at the factory. The machine can be used for approximately 20 days without resupplying the lubrication oil, assuming that the hammer is used continuously for 3-4 hours daily. Check the oil level before use. The oil level should be approximately 3mm above the oil gauge window.

Check the oil level by standing the machine upright and view the oil level through the window. If low;

1. Place the machine on a flat surface with the oil gauge window facing upwards.
2. Using the wrench, remove the oil gauge window cover.
3. Top up the oil well using the oil bottle supplied. (no more than 25ml at a time.)
  - DO NOT overfill the chamber.
4. Replace the oil gauge window cover and tighten with wrench before using the hammer again.

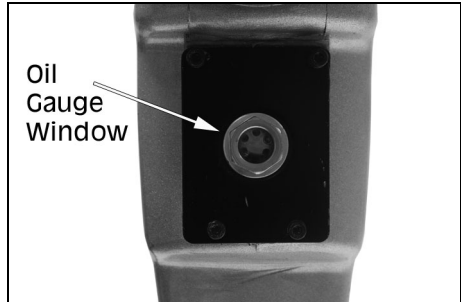

### POSITIONING THE AUXILIARY HANDLE

The front handle can be positioned left, right or centre as required.

1. Loosen the handle adjustment knob by twisting it clockwise.
2. Rotate the handle to the required position.
3. Secure the handle by twisting the handle adjustment knob anticlockwise.

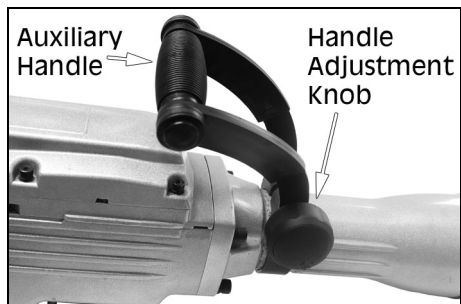

### INSERTING A HAMMER BIT / CHISEL

The chuck clamps SDS 30mm Hex hammer bits and chisels without the need for a chuck key.



1. Clean and grease the chisel shank. DO NOT lubricate the machine.
2. Pull out and rotate the stop lever 180 degrees clockwise
3. Insert the chisel into the chuck clamp with the flat face of the chisel facing the stop lever.
4. Pull out and rotate the stop lever 180 degrees anticlockwise to lock the chisel in place.

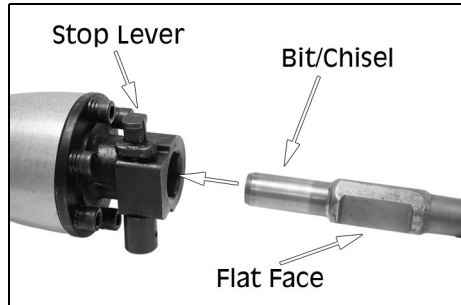

5. Check by pulling the chisel to see if it is locked in place.

**NOTE:** Be aware that the hammer action requires the chisel to be able to move axially by 2-3 cm.

6. To remove the chisel, reverse the above steps.
7. DO NOT allow dust or debris inside the chuck as this will cause problems in the future.



CAUTION: WHEN REMOVING A BIT FROM THE HAMMER, REMEMBER THAT IT MAY BE EXTREMELY HOT. EITHER ALLOW IT TO COOL DOWN FIRST OR USE INDUSTRIAL GLOVES TO REMOVE THE BIT.

## USING THE HAMMER FUNCTION

**WARNING: ALWAYS CHECK OIL LEVEL BEFORE USE - SEE PAGE 8**

### BEFORE STARTING WORK

1. Before hammering into walls and floors etc., check first that there are no hidden electrical cables, gas or water pipes etc.
2. Check the mains voltage (230v~50Hz) before plugging in and switching on.
3. Ensure the work area is as hazard free as possible.

### STARTING WORK

1. Select and install the chisel to be used. See page 8.
2. If required, adjust the auxiliary handle for the most comfortable position, see page 8.
  - For safety, always use the hammer with the auxiliary handle attached.

3. Position the tool against the surface to be hammered and pull the trigger switch.
4. For continuous use, press the trigger lock button after pressing the trigger.

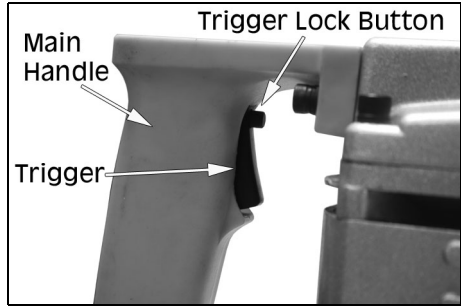

## STOPPING WORK

1. Release the trigger or press the trigger if in continuous use mode and wait until the chisel has stopped before placing the hammer on any surface.

## HAMMERING TIPS

- Always use sharp, good quality hammer bits/chisels. The performance of your hammer is dependant on the quality of the bits used.
- Reduce the pressure on the hammer bit when it is about to break through. This will prevent the hammer from jamming.
- If hammering a large hole, first hammer a pilot hole using a smaller hammer bit.
- Always apply pressure to your hammer bit in a straight line.







---

## MAINTENANCE AND SERVICING

---

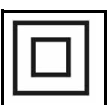

1. After use, remove the hammer bit and tap the side of the chuck to remove any dust or chippings etc.
2. Keep the handle clean and free from oil and grease.
3. Worn or damaged parts must be replaced by qualified personnel.
4. Clean the tool regularly, use a soft brush and/or soft cleaning cloth. DO NOT use any chemicals or harsh abrasives to clean the tool.
5. At the end of work, to prevent dust deposits you should use compressed air (max.3 bar) to clean out the ventilation holes. When using compressed air ALWAYS wear the correct PPE and eye protection.

## SAFETY SYMBOLS

	Read Instruction Manual Before Use		Wear Dust Mask
	Wear Safety Footwear		Wear Ear Defenders
	Wear Safety Gloves		Wear Safety Glasses
	WEEE Directive		Class 2 Double Insulated

## ACCESSORIES & RELATED PRODUCTS

For accessories, please contact your nearest Clarke dealer.

Fully Synthetic Motor Oil - 5W40	Bull Point Chisel	34mm Flat Head Chisel
		
<ul style="list-style-type: none"> <li>• 1 litre</li> <li>• Part No. 13050858</li> </ul>	<ul style="list-style-type: none"> <li>• 30mm x 410mm</li> <li>• Part No. 6479551</li> </ul>	<ul style="list-style-type: none"> <li>• 30mm x 410mm</li> <li>• Part No. 6479552</li> </ul>

# PARTS DIAGRAM

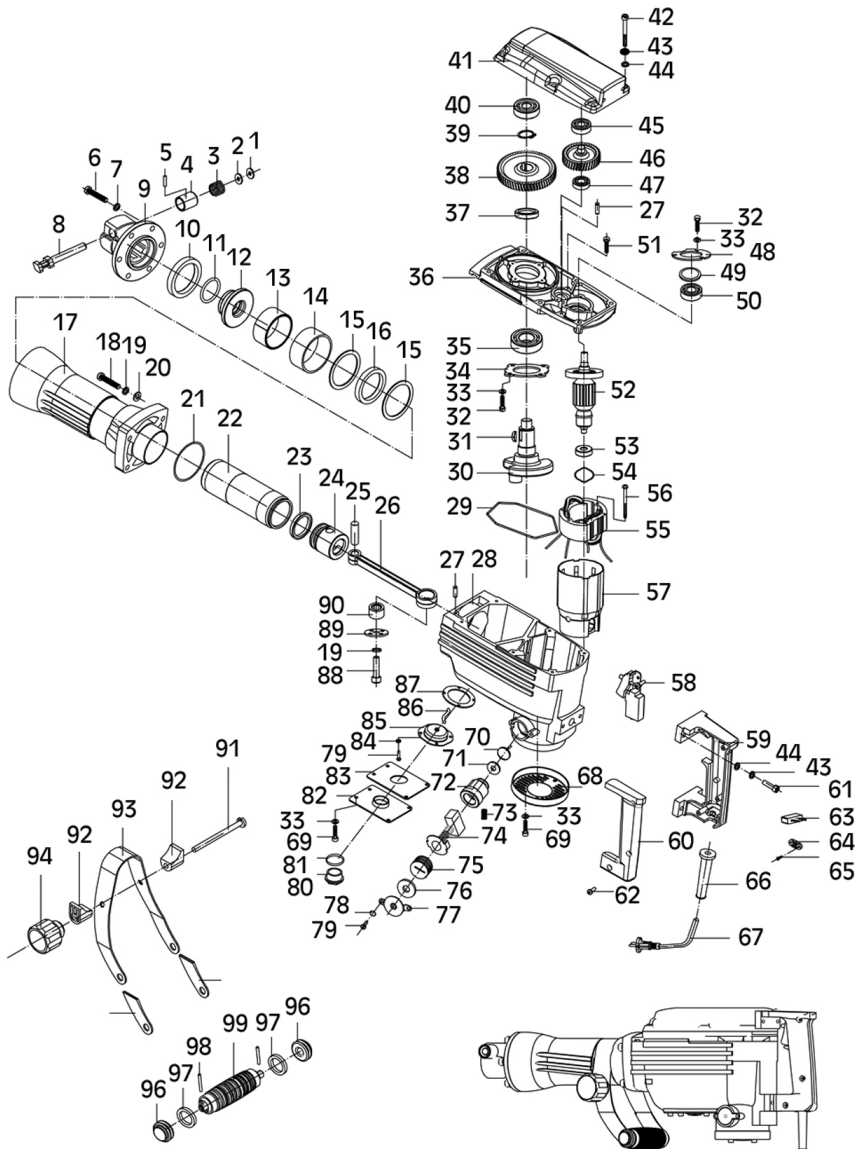

## PARTS LIST

ID	DESCRIPTION	ID	DESCRIPTION
1	Washer 12.5 x 18 x 0.8	31	Key 4 x 6.5 x 16
2	Washer 12.4 x 17.6 x 2.6	32	Hex. Socket Bolt M5 x 25
3	Spring 17.5 x 1.3 x 26.5	33	Washer
4	Spring Case 23 x 28	34	Bearing Cover
5	Pin 4 x 18	35	Bearing 6205
6	Nylock Hex. Socket Bolt M10 x 35	36	Inner Cover
7	Washer	37	Ring 22.5 x 34 x 7.5
8	Stop Lever	38	Gear 63
9	Front Cover	39	Ring 22
10	Damper 47.5 x 66.5 x 14.3	40	Bearing 6302
11	O Ring 23.6 x 5	41	Gear Cover
12	Shank Sleeve	42	Hex. Socket Bolt M6 x 45
13	Ring	43	Washer
14	Ring 64.5 x 67.5 x 27.5	44	Washer
15	Ring 57.5 x 68.4 x 2	45	Bearing 6201
16	Damper 58 x 68 x 9.3	46	Gear 20CrMnTi/HRC48-52
17	Cylinder House	47	Bearing 6001
18	Hex. Socket Bolt M8 x 35	48	Bearing Cover 6203
19	Washer	49	Bearing Washer 29.5 x 39.5 x 2
20	Washer	50	Roll Bearing 6203
21	O-Ring 60 x 2	51	Nylock Hex. Socket Bolt M6 x 14
22	Cylinder	52	Rotor
23	O Ring	53	Bearing 6201
24	Piston	54	Washer 31 x 25 x 0.5
25	Pin 12 x 34	55	Stator
26	Connecting Rod	56	Hex. Socket Bolt M5 x 55
27	Pin 5 x 14	57	Stator Housing
28	Gear Casing	58	Switch
29	Ring	59	Handle
30	Crankshaft	60	Handle Cover

<b>ID</b>	<b>DESCRIPTION</b>	<b>ID</b>	<b>DESCRIPTION</b>
61	Nyloc Hex. Socket Bolt M5 x 55	84	Washer
62	Self Tapping Screw ST3.9 x 20	85	Felt Holder
63	Capacitor 0.33uF	86	Oil Felt 7 x 70
64	Cable Plate	87	Felt Holder Seal
65	Self Tapping Screw ST3.9 x 16	88	Nylock Hex. Socket bolt M8 x 30
66	Cable Cover	89	Bearing Cover 24.5 x 2.3
67	Cable	90	Bearing NK18/20
68	Chassis	91	Nut M8 x 10
69	Nylock Hex. Socket Bolt M5 x 12	92	Plastic Block
70	Spring	93	Hand Grip
71	Brush Washer	94	Knob
72	Brush Holder	95	Rubber Cover
73	Nylock Hex. Socket Bolt M5 x 8	96	Handshaft
74	Brush 7 x 17 x 18	97	Handshaft Cover
75	Brush Holder Cap	98	Pin
76	Washer 10 x 26 x 3	99	Auxiliary Handle
77	Brush Cover		
78	Washer		
79	Cross Bolt M4 x 14		
80	Oil Gauge		
81	O Ring 23 x 2		
82	Oil Box Cover		
83	Washer		

# DECLARATIONS OF CONFORMITY



## DECLARATION OF CONFORMITY

This is an important document and should be retained.

**We hereby declare that this product(s) complies with the following legislation:**

*Noise Emission in the Environment by Equipment for use Outdoors Regulations 2001*  
*The Electromagnetic Compatibility Regulations 2016*  
*The Supply of Machinery (Safety) Regulations 2008*  
*The Restriction of the Use of Certain Hazardous Substances in Electrical and Electronic Equipment Regulations 2012*

**The following standards have been applied to the product(s):**

*EN 61000-3-3:2013+A1:2019+A2:2021, IEC 62321-4:2013+AMD1:2017 CSV, EN IEC 55014-1:2021, EN IEC 62841-2-6:2020+A11:2020, EN 62841-1:2015+A11:2022, IEC 62321-1:2013, IEC 62321-2:2013, EN IEC 61000-3-2:2019+A1:2021, EN IEC 55014-2:2021, IEC 62321-3-1:2013, IEC 62321-7-1:2015, IEC 62321-7-2:2017, IEC 62321-5:2013, IEC 62321-6:2015, ISO 17075-1:2017, EN ISO 3744:2010*

The technical documentation required to demonstrate that the product(s) meet(s) the requirement(s) of the aforementioned legislation has been compiled and is available for inspection by the relevant enforcement authorities.

The UKCA mark was first applied in: 2022

<b>Manufacturer:</b>	Clarke International Ltd, Hemnall Street, Epping, Essex, CM16 4LG, United Kingdom	<b>Notified Body:</b>	Ente Certificazione Macchine S.r.l (ID Number: 1282), Via Cà Bella 243, 40053 Valsamoggia, Bologna, Italy
<b>Product Description:</b>	Demolition Hammer	<b>Assessment Procedure:</b>	Annex VI of above noise legislation
<b>Model Number(s):</b>	CON1500DD	<b>Measured LWA:</b>	98 dB
<b>Serial/Batch Number:</b>	Refer to product/packaging label	<b>Guaranteed LWA:</b>	105 dB
<b>Document Holder:</b>	Alan Pond	<b>Signed:</b>	 J.A. Clarke
<b>Date of Issue:</b>	26/10/2023		Director

CON1500DD UKCA Clarke DOC 102623

Page 1 of 1



## DECLARATION OF CONFORMITY

This is an important document and should be retained.

**We hereby declare that this product(s) complies with the following legislation:**

*2000/14/EC Outdoor Noise Directive*  
*2014/30/EU Electromagnetic Compatibility Directive*  
*2006/42/EC Machinery Directive*  
*2011/65/EU Restriction of Hazardous Substances (RoHS) Directive*

**The following standards have been applied to the product(s):**

*EN 61000-3-3:2013+A1:2019+A2:2021, IEC 62321-4:2013+AMD1:2017 CSV, EN IEC 55014-1:2021, EN IEC 62841-2-6:2020+A11:2020, EN 62841-1:2015+A11:2022, IEC 62321-1:2013, IEC 62321-2:2013, EN IEC 61000-3-2:2019+A1:2021, EN IEC 55014-2:2021, IEC 62321-3-1:2013, IEC 62321-7-1:2015, IEC 62321-7-2:2017, IEC 62321-5:2013, IEC 62321-6:2015, ISO 17075-1:2017, EN ISO 3744:2010*

The technical documentation required to demonstrate that the product(s) meet(s) the requirement(s) of the aforementioned legislation has been compiled and is available for inspection by the relevant enforcement authorities.

The CE mark was first applied in: 2020

<b>Manufacturer:</b>	Clarke International Ltd, Fitzwilliam Hall, Fitzwilliam Place, Dublin 2, Republic of Ireland	<b>Notified Body:</b>	Ente Certificazione Macchine S.r.l (ID Number: 1282), Via Cà Bella 243, 40053 Valsamoggia, Bologna, Italy
<b>Product Description:</b>	Demolition Hammer	<b>Assessment Procedure:</b>	Annex VI of above noise legislation
<b>Model Number(s):</b>	CON1500DD	<b>Measured LWA:</b>	98 dB
<b>Serial/Batch Number:</b>	Refer to product/packaging label	<b>Guaranteed LWA:</b>	105 dB
<b>Document Holder:</b>	Alan Pond	<b>Signed:</b>	 J.A. Clarke
<b>Date of Issue:</b>	26/10/2023		Director

CON1500DD CE Clarke DOC 102623

Page 1 of 1

# A SELECTION FROM THE VAST RANGE OF

# Clarke®

## QUALITY PRODUCTS



### **AIR COMPRESSORS**

From DIY to industrial, Plus air tools, spray guns and accessories.

### **GENERATORS**

Prime duty or emergency standby for business, home and leisure.

### **POWER WASHERS**

Hot and cold, electric and engine driven - we have what you need

### **WELDERS**

Mig, Arc, Tig and Spot. From DIY to auto/industrial.

### **METALWORKING**

Drills, grinders and saws for DIY and professional use.

### **WOODWORKING**

Saws, sanders, lathes, mortisers and dust extraction.

### **HYDRAULICS**

Cranes, body repair kits, transmission jacks for all types of workshop use.

### **WATER PUMPS**

Submersible, electric and engine driven for DIY, agriculture and industry.

### **POWER TOOLS**

Angle grinders, cordless drill sets, saws and sanders.

### **STARTERS/CHARGERS**

All sizes for car and commercial use.

## **PARTS & SERVICE:**

## **0208 988 7400**

### **Parts Enquiries**

[Parts@clarkeinternational.com](mailto:Parts@clarkeinternational.com)

### **Servicing & Technical Enquiries**

[Service@clarkeinternational.com](mailto:Service@clarkeinternational.com)

SALES: UK 01992 565333 or Export 00 44 (0)1992 565335

**Clarke** INTERNATIONAL Hemnall Street, Epping, Essex CM16 4LG  
[www.clarkeinternational.com](http://www.clarkeinternational.com)